

# **Manual**

**192F-2TD Motor Bensin 14,96 hk 459cc**

## PREFACE

Thank you for choosing a general gasoline engine by the company.

The manual gives information with respect to operation and maintenance of the general gasoline engine, and be sure to read it carefully first before operation. All the materials and diagrams of this manual are in accordance with the newest products at the publishing time. Due to revision and other change, the information described in this manual may be a little different from the actual status. The copy right of this book belongs to our Co., any group or individual is forbidden to reprint or copy it .The manual is subject to change without notice.

Please pay special attention to statements preceded by the following words:

### **WARNING:**

**Indicates a strong possibility of severe personal injury or death if instructions are not followed.**

### **CAUTION:**

**Indicates a possibility of personal injury or equipment damage if instructions are not followed.**

### **NOTE:**

**Give helpful information.**

Although the engine conforms to the safety requirement of EN1679-1, the user must notice the possible danger when they install the engine with other terminal products because the different installing purposes maybe will result in new danger to the engine and its driving product. So, all users must be responsible to take action for assuring the safety.

# CONTENTS

Safety precautions .....	(1)
Parts description .....	(2)
Battery connection (only for electric-start type) .....	(3)
Control connection of remote distance (option) .....	(4)
Pre-operate inspection .....	(6)
Starting the engine .....	(11)
Running the engine .....	(13)
Stop.....	(15)
Exhaust control system .....	(17)

Maintenance .....	(19)
Transport, storage and removal from storage.....	(28)
Troubleshooting .....	(31)
Specifications .....	(43)
Electric diagram .....	(45)

# SAFETY PRECAUTIONS

## WARNING:

**Before operating the engine, be sure to read and familiar with the manual carefully, otherwise personal injury or equipment damage may produce.**

Please pay special attention to the following:

1. Running the engine in a well-ventilated place, keep it at least one meter away from building walls or other equipments, keep away from inflammables such as gasoline, matches and so on to avoid possibility of fire.
2. Keep the engine out of reach of children and pets to avoid accidents.
3. Operator of the engine has been specially trained.
4. Refuel in a well-ventilated area with the engine stopped, and in places refueling or storing gasoline, no smoking and any flames or sparks.
5. Refuel the fuel tank not too full so as to avoid fuel's spilling out. If there is spilled fuel around, be sure to clean it thoroughly before starting.
6. Locate the engine on a level-working platform to avoid fuel's spilling out.
7. Make sure the fuel filler cap is tightened securely.
8. The exhaust muffler is very hot during running the engine even after the engine stops. Never touch it, or you may get burns. Transport or store the engine with it cooling down entirely.
9. This machine should not be used underground or in areas where explosive conditions may be present.
10. It's recommended that the operator wears the ear protection equipment during operation.

# PARTS DESCRIPTION

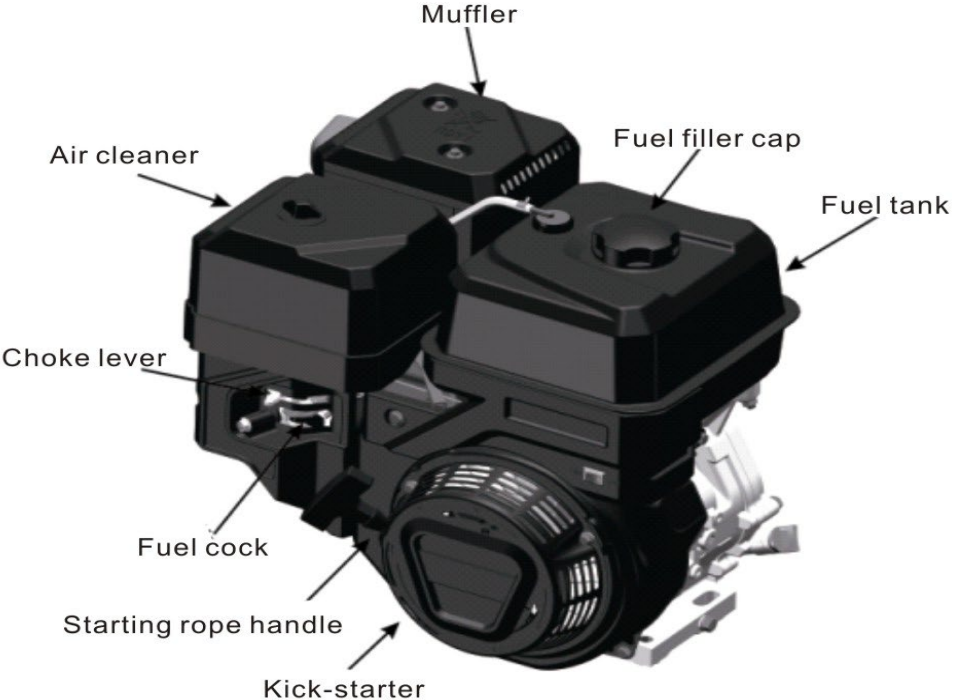

## **BATTERY CONNECTION (Only for electric-start type)**

In the case that the specifications of the battery are 12V and more than 18A.h, connect its positive lead to the electromagnetic coil while connect its negative lead to engine mount screw, base screw or any place capable of grounding with the engine well.

Make sure the battery leads are connected tightly and no corrosion is found. If any, eliminate it.

### **WARNING:**

- **The battery may give off explosive gas, keep sparks, flames and cigarettes away. Charge or use it in an area with good ventilation.**
- **The battery contains sulphuric acid (electrolyte). Contact with skin or eyes may cause severe burns. Wear protective clothing and a face shield.**  
**If electrolyte gets in your skin, flush with water; if gets in your eyes, flush with water for at least 15 minutes and call a physician at once.**
- **Electrolyte is poisonous. If swallowed, drink large quantities of water or milk, and follow with milk of magnesia or vegetable oil and call a physician.**
- **Keep out of reach of children.**

### **CAUTION:**

- **Do not add tap water to the battery instead of distilled water, or the battery life will be shortened.**
- **Do not add distilled water over electrolyte upper level mark, or electrolyte will spill out to corrupt the engine parts. If so, be sure to wash them away with water.**

- **Make sure not to connect the battery leads in reverse order, or short-circuit or breaker's cutting may result.**

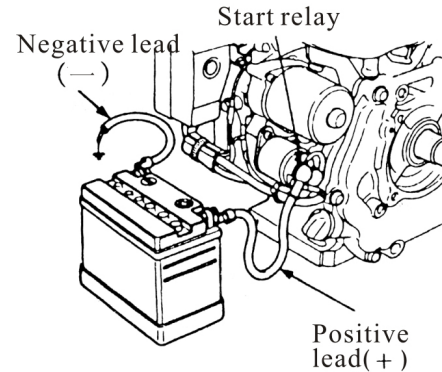

## **CONTROL CONNECTION OF REMOTE DISTANCE (OPTION)**

The holes in levers of both the choke and throttle are used for mounting optional steel wires. The diagrams shown illustrate how to mount a solid steel wire and a meshed steel wire. If choosing a meshed steel wire, a retaining spring is in need.

If necessary, you may screw loose the damping nut on the throttle lever slightly when controlling the throttle by a remote-controlled steel wire

### Accessory options

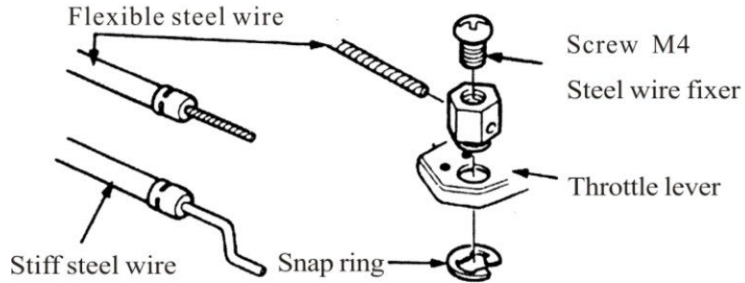

### Remote-controlled throttle

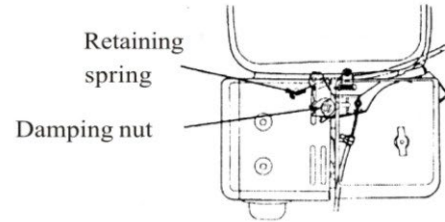

### Remote-controlled choke

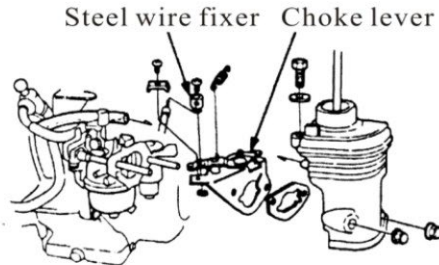
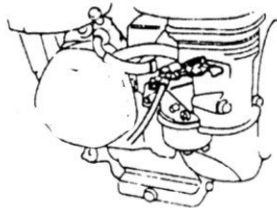

# PRE-OPERATE INSPECTION

## ENGINE OIL

### CAUTION:

- Engine oil is a key factor in deciding the engine's Performance. Do not apply engine oil with additives or 2-stroke gasoline engine oil, as they haven't enough lubrication, which may shorten the engines service life.
- **Check the engine with it stopped on a level ground.**  
Engine oil recommended: SAE10W-30  
As viscosity varies with regions and temperatures, so the lubricant has to be selected in accordance with our recommendation.

### Check

1. Ensure that the engine is stopped on a level ground.
2. Remove the dipstick and clean it.
3. Reinsert the dipstick into the oil filler without screwing it, and check oil level.

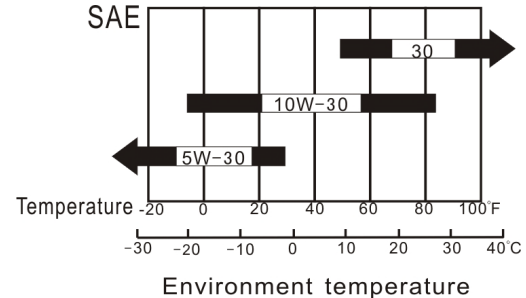

4. If the oil level is too low, add the recommended engine oil up to the oil filler neck.
5. Reinstall the dipstick.

**CAUTION: Run with insufficient engine oil may damage the engine Severely.**

### **OIL IN THE REDUCTION GEAR BOX (only for the model equipped with it)**

1/2 Reduction gear with an auto-centrifugal clutch  
brand of box oil is the same as that of engine oil.

Oil capacity: 1.10 liters

1. Remove the dipstick and clean it .
2. Reinsert the dipstick without screwing it in, and then check oil level.
3. If the oil level is too low, add the recommended engine oil until it arrives the upper level mark.
4. Reinstall the dipstick.

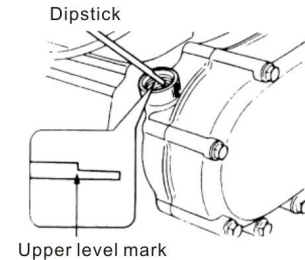
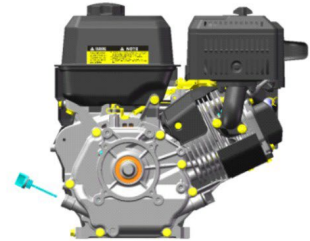
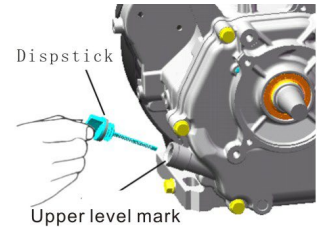

# AIR CLEANER

## I. Double-core type

Dismantle the air cleaner housing and check its filter element, make sure it clean and intact, otherwise clean or replace it.

### CAUTION:

**Never run the engine without an air cleaner, or severe wear of the engine may result.**

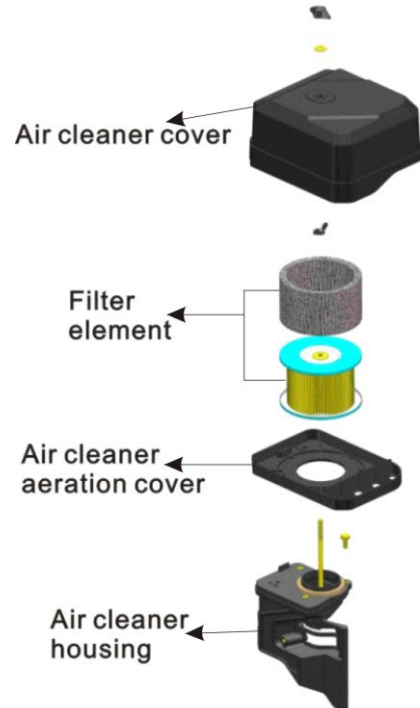

# FUEL AND FUEL TANK

## Fuel

The engine must apply unleaded gasoline with an octane number over 86. Using unleaded gasoline will decrease the possibility of producing carbon deposit and will prolong the engine's service life. Never apply used or polluted gasoline or a mixture of gasoline with engine oil. Make sure the fuel is free of dirt and water.

## Gasoline Containing Alcohol

If you decide to use a gasoline containing alcohol (fuel blend), be sure its octane rating is at least as high as high as that recommended by the company. There are two types of "gasohol" . One contains ethanol, and the other contains methanol. Neither gasoline containing more than 10% ethanol nor 5% methanol is allowed to be used. If methanol content in the fuel blend exceeds 5%, it may bring bad effect on the engine performance, besides, it may damage metals, rubber and plastic parts.

## CAUTION:

If "spark knock" or "pinking" occurs at a steady speed under normal load, change brand of gasoline; if such phenomena still happen, consult your dealer for help, otherwise the engine may be damaged.

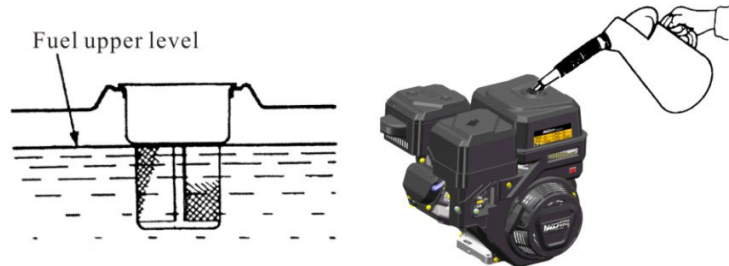

## **Fuel Tank**

Fuel tank capacity 6.5 liters for 192F-2T.

### **Check**

1. Remove the fuel filler cap and check fuel level.
2. If the level is too low, refuel the tank. Remember adding fuel not over the fuel filler shoulder.

### **WARNING:**

- **Gasoline is extremely flammable and is explosive under certain conditions. Refueling in a well-ventilation area with the engine stopped. Do not smoke and allow flames or sparks in the area where gasoline is stored or where the fuel tank is refueled.**
- **Do not overfill the tank (there should be no fuel in the filler neck). After refueling, make sure the fuel filler cap is set back securely.**
- **Be careful not to spill fuel when refueling. Spilled fuel or fuel vapor may ignite. If any fuel is spilled, make sure the area is dry before starting the engine.**
- **Avoid repeated or prolonged contact with skin or breathing of fuel vapor. Keep out of reach of children.**

## STARTING THE ENGINE

1. Push the fuel cock to “ ON ”.

2. Push the choke lever to “ CLOSE ”.

NOTE: if the engine is hot, closing the choke is unnecessary.

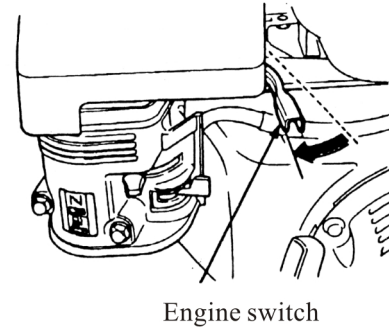
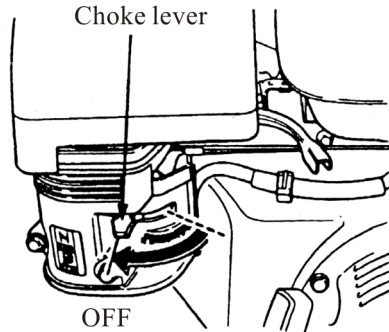
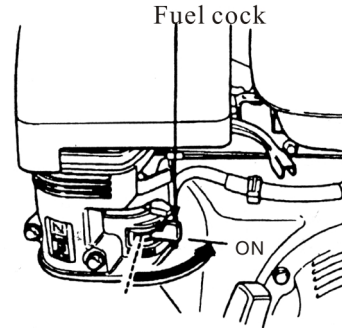

3. Move left the throttle lever a little.

4. Start the engine as follows:

a) Hand-operated kick-starter

Push the engine switch to “ ON ”.

Pull slightly the starting rope handle up until feeling anti-action, and then make a rapid pull.

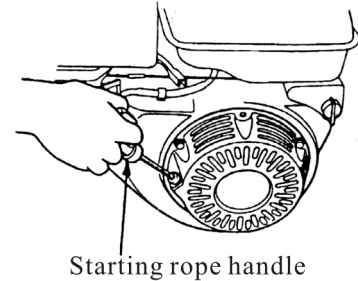
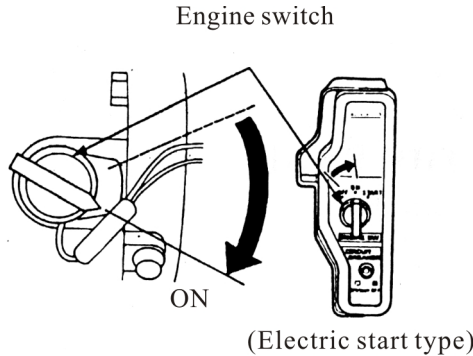

**CAUTION:**

**Releasing the handle suddenly may make it hitting the engine. Release the handle slowly conforming with its recoiling force.**

b) Electric starter

Push the engine switch to “ START ” and remain there until the engine starts.

Once the engine starts, reset the engine switch to “ ON ”.

**CAUTION:**

**Use the engine switch not than 5 minutes each time to avoid damage of the engine. Try once more 10 minutes later after last attempt failures.**



## RUNNING THE ENGINE

1. Preheat the engine and push back the choke lever to “ OPEN ”.

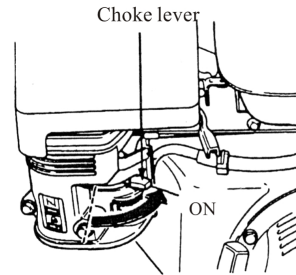

2. Set the throttle lever in proper position to ensure the engine runs at required velocity.

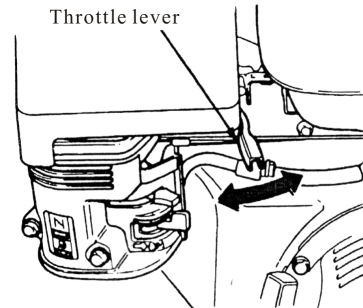

## ENGINE OIL ALARM

The engine oil alarm is designed to function when the engine oil in the crankcase is insufficient. Lack of engine oil may damage the engine. Once oil level in the crankcase is too low, the engine oil alarm will stall the engine automatically to make it free of damage while the engine switch is still at “ ON ”.

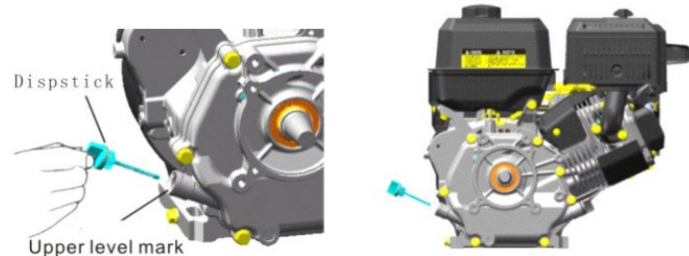

## CAUTION:

**If cannot restart the engine, check the engine oil level first before go to other check items.**

## BREAKER (Electric-start type)

The breaker will cut off automatically to protect the charging circuit of the battery in the case that short circuit or incorrect connection of the battery poles occurs.

The green indicator in the breaker will jump out with the circuit cutting off. After finding troubles and troubleshooting, depress the breaker button to turn the breaker on.

## OPERATING ON HIGHLANDS

On highlands, the standard mixture ratio is relatively too big so the engine performance may be impaired while the fuel consumption may increase, besides, too big mixture ratio will pollute the spark plug to result in starting the engine difficultly. This problem can be solved by amending the carburetor technological status. If always using on highlands with a height above sea level of 1800 meters, ask your dealer for doing the job.

However, the engine power will decrease by about 3.5% with every 305 meters up in height.

## CAUTION:

**Amended engine applicable to highlands may be damaged seriously in area below altitude of 1800 meters for overheating, because its mixture ratio is too small for operation in low altitude area. In the case, ask your dealer to recover the engine to its normal technical status.**

## STOP

In emergency, push the engine switch to “ OFF ” to stall

The engine to stop it in normal, do as follows:

1. Push right the throttle lever to the bottom.



2. Push the engine switch to “ OFF ”.
3. Set the fuel cock to “ OFF ”.

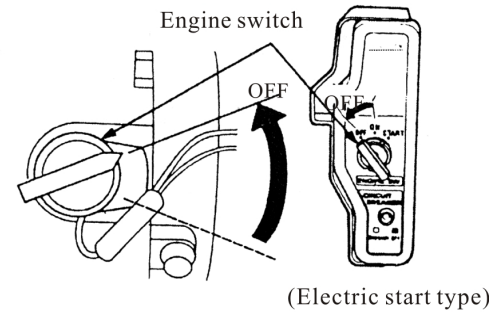
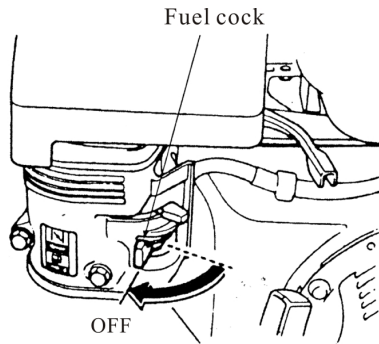

**CAUTION:**

**Sudden stopping at high speed under heavy load is forbidden, otherwise damage will result.**

## **EXHAUST CONTROL SYSTEM**

With the engine running, carbon monoxide, oxide of nitrogen and hydrocarbon will produce, and in certain conditions, oxide of nitrogen and hydrocarbon will react chemically each other to make smoke while carbon monoxide is toxic, so exhaust control of them is very important. The company decreases the exhaust emissions by introducing poor-fuel carburetors and other devices into the engine to solve the problem.

To keep the exhaust of your engine with in the standard exhaust emission, pay attention to the following:

### **1. Maintenance**

Maintain the engine periodically in accordance with the maintenance schedule in the manual. The maintenance schedule is made out on the base of normal use in normal conditions, if using under heavy load, dusty or wet circumstances or in high temperature, service of the engine should be done more often.

### **2. Replacement of parts**

We recommend that you should choose such parts which are manufactured by the company or equivalent to these in quality as replacement ones. Replacement without so high quality as the original may impair the exhaust control system in effectiveness.

### **3. Modifying**

Modifying the exhaust control system may make actual exhaust emissions exceeding statutory limit values.

Illegal modification as such:

- a) Dismantle or modify any part of air intake or exhaust system.
- b) Modify or take off speed – adjusting connection device or speed adjustment device to result in the engines running beyond the set parameters.

### **4. Problems affecting exhaust emissions**

- a) Difficult starting or difficult stopping.
- b) Unstable idling.
- c) Give off back smoke or consume too much fuel.
- d) Poor ignition sparks or sparks returned.

Once you find any of above problems, contact your dealer for help.

## MAINTENANCE

### MAINTENANCE SCHEDULE

Frequency		Each time	First month or 20 hrs	Each season or 50 hrs	Every 6 month or 100 hrs	Each year or 300 hrs
Item						
Engine oil	Oil level check	√				
	Replace		√		√	
Reduction gear oil	Oil level check	√				
	Replace		√		√	
Air cleaner	Check	√				
	Clean			√ ①	√ ①*	
	Replace					√ **
Deposit cup	Clean				√	
Spark plug	Clean, adjust				√	
	Replace					√
Spark eliminator	Clean				√	
Idling	Check-adjust					②
Valve clearance	Check-adjust					②
Fuel tank & fuel filter	Clean					②
Fuel supply line	Check	Every two years (do a replacement if necessary)				

## CAUTION

Use only parts from the company or equivalents in quality; otherwise engine damage may result.

## NOTE:

\*: only for inside-ventilating double-core carburetors.

\*\* : only for paper core air cleaners. Every two years or 600 hour's later for dust collecting air cleaners.

① More often than that in the schedule if in dusty circumstances.

② Should be done by your dealer unless you are specially trained and is well equipped with tools.

## WARNING:

Stall the engine before service. If service is required with the engine running, be sure to keep good ventilation in the area. The exhaust emissions from the engine contain toxic carbon monoxide, inbreathing of it may result injury and even death.

## REPLACEMENT OF ENGINE OIL

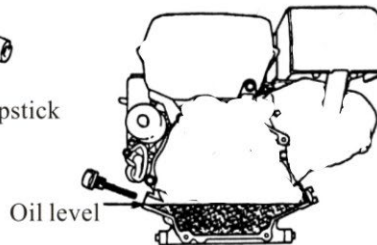
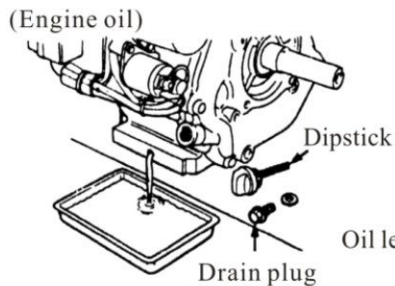

(Engine oil in the reduction gear box)

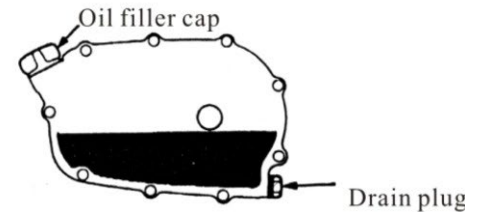

A still hot engine is helpful to drain out the engine oil in the crankcase rapidly and entirely.

1. Turn off the oil filler cap and drain plug to drain engine oil thoroughly. Reinstall the drain plug and screw in securely.
2. Fill the specified engine oil up to the upper level mark.
3. Reinstall the oil filler cap.

Engine oil capacity in the reduction gearbox is 0.3 liters, engine oil capacity in the crankcase is 1.1 liters.

#### **NOTE:**

**Do not dump oil containers or discarded engine oil into rubbish boxes or onto the ground. For the sake of environmental protection, we suggest you take in discarded engine oil with a closed container and bring to local recycling station.**

#### **SERVICE OF AIR CLEANER**

A dirty air's flowing into the carburetor. To keep the carburetor in good working conditions, please service the air cleaner periodically. If operating the engine in extremely dusty area, the job should be done more often.

#### **WARNING:**

**Never clean the air cleaner core in gasoline or low flash-point detergents, or explosion may happen.**

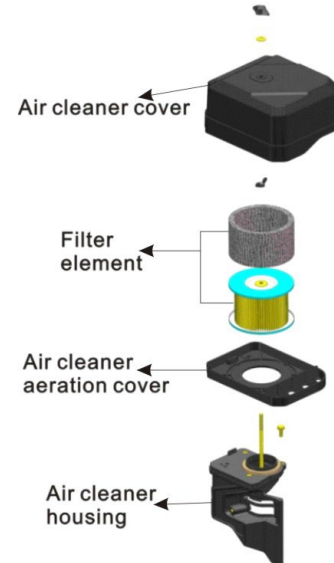

**CAUTION:**

**Never run the engine without an air cleaner, or air with dirt and dust may enter the engine so speed the engine's wear.**

Unscrew the wing nut, dismantle the air cleaner housing. Check if the two cores are damaged, if so, replace with new one.

a) Foam filter element: clean with home detergents and warm water (or non-flammable or high flash-point cleansing solvents) and dry up, then soak in clean engine oil until saturated. Squeeze out excess oil, otherwise, the engine will discharge smoke in starting stage.

b) Paper filter element: knock the core against a solid plane to get rid of accumulated dust or blow out dust from inside to outside with high-pressure air flow (not more than 30 psi). Never clean with a brush, as brushing may force the dust into the core fiber. If the core is extremely filthy, replace with a new one.

**Dust-collecting type**

1. Unscrew the wing nut, dismantle the air cleaner housing, check if the two cores are damaged, if so, replace with new one.

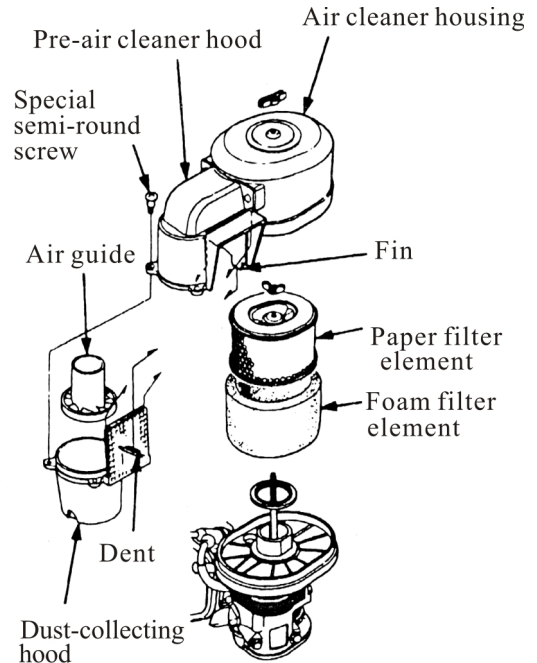

- a) Foam filter element: clean with home detergents and warm water (or non-flammable or high flash-point cleansing solvents ) and dry up, then soak in clean engine oil until saturated. Squeeze out excess oil, otherwise, the engine will discharge smoke in starting stage.
  - b) Paper filter element: knock the core against a solid plane to get rid of accumulated dust or blow out dust from inside to outside with high-pressure air flow (not more than 30psi). Never clean with a brush, as brushing may force the dust into the core fiber. If the core is extremely filthy, replace with a new one.
2. Clean the dust-collecting hood: screw off the three special semi-round screw and remove the hood, wash parts with water and then dry up. Reinstall the hood.

### **CAUTION:**

- **When reinstalling the dust collecting core air cleaner, make sure to embed the fin on the pre-air cleaner hood in the dent in the dust- collecting hood.**
- **Install the air guide in correct order.**

### **Single-core type**

1. Remove the wing nut and air cleaner housing, and take out the filter element.
2. Clean with home detergents (or high flash-point cleansing solvents) and warm water, and dry up.
3. Soak in clean engine oil until saturated; squeeze oil, or the engine will exhaust smoke in starting stage.
4. Reinstall the filter element and air cleaner housing.

## Oil bath type

1. Remove the nut and air cleaner housing, and take out the filter element.
  2. Clean with home detergents (or high flash-point cleansing solvents) and warm water, and dry up.
  3. Soak in clean engine oil until saturated. Squeeze excess oil, or the engine will discharge smoke in starting stage.
  4. Empty the air cleaner housing of oil. Clear away the dust in side with non-flammable or high flash-point cleansing solvents, and dry it up.
  5. Fill the air cleaner housing with the specified engine oil up to the standard oil level mark.
  6. Reinstall the air cleaner
- Oil capacity: 1.1L.

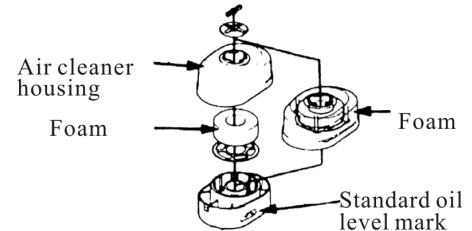
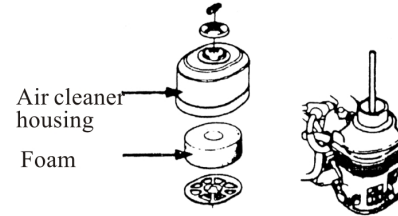

## WASHING OF DEPOSIT CUP

Set the fuel cock at “ OFF ”, disconnect the deposit cup and O-ring. Wash in non-flammable or high flash-point cleansing solvents, and then try them up, at last, reinstall it. Set the fuel cock to “ ON ”and check for leaks.

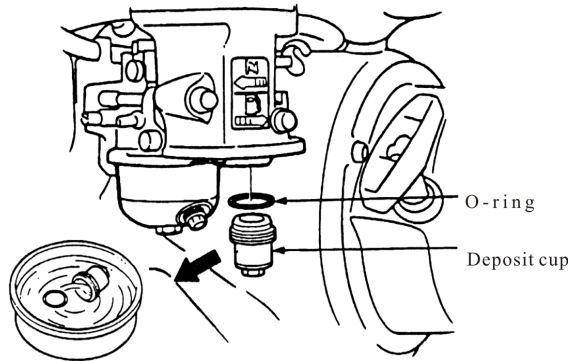

### WARNING:

- Gasoline is extremely flammable and explosive in certain condition. Keep cigarette, sparks and open flames away.
- After reinstalling the deposit cup, make sure the area around

## spark plug

Spark plug type: BPR6ES (NGK) or NHSP LD F7RTC

Proper spark plug clearance ensures the engine's normal running under no deposit around the spark plug.

1. Remove the spark plug cap.
2. Clear away dirt around the spark plug base.
3. Dismantle the spark plug with a spark plug wrench.
4. Clean with a steel brush. If the insulator is damaged, replace the spark plug instead.
5. Measure the spark plug clearance with a feeler. The clearance should be 0.7~0.8mm. If adjustment is necessary, bend the side electrode carefully.
6. Check if the spark plug gasket is in good conditions, or replace with a new one. Screw on the spark plug to the bottom first by hand a then screw in by a spark plug wrench. If a new spark plug is used, twist 1/2 more turns after impacting the gasket, if reinstall the original one, just twist 1/8-1/4 more turns.

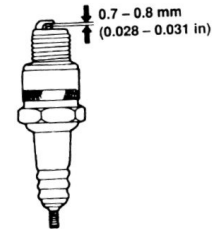
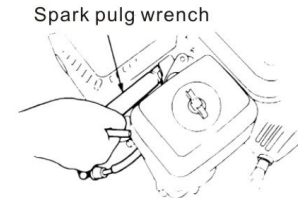

### CAUTION:

- The spark plug must be tightened securely, or it may become very hot to damage the engine.

- Only use recommended spark plug or the equivalent. Incorrect heat range of the spark plug may damage the engine.

## SPARK ELIMINATOR (Option)

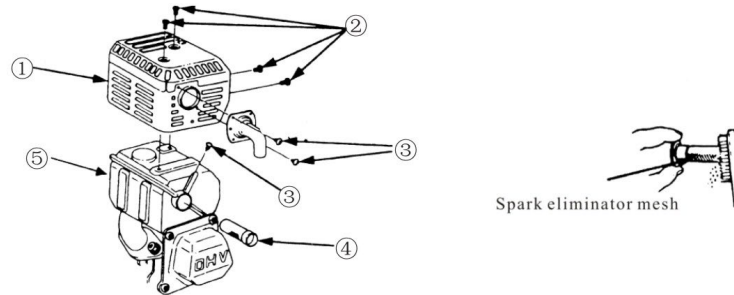

The spark eliminator should be serviced at least once every 100 hour's operation so as to keep it in a sound condition.

### **WARNING:**

The muffler is very hot during running the engine and even a long time after stopping. Never touch it, or you may get burns. Service after the engine cools down.

1. Unscrew the two nuts M8⑥, and disconnect the muffler⑤ from the engine body.
2. Turn off the four screws M5② from the muffler hood① and disconnect the hood.
3. Turn off the screw M4③ from the spark eliminator④ and separate it from the muffler.
4. Clear away carbon deposit from the spark eliminator mesh with a brush.
5. Reinstall the spark eliminator in reverse order of removal.

**CAUTION:**

- **Be careful not to damage the mesh of the spark eliminator.**
- **Never use a damaged spark eliminator.**

## **CARBURETOR IDLING ADJUSTMENT**

1. Start and preheat the engine until arriving at the normal working temperature.
2. Obtain standard idling by adjusting the throttle fixing screw under the engine's idling.

Standard idling: 1500±100rpm.

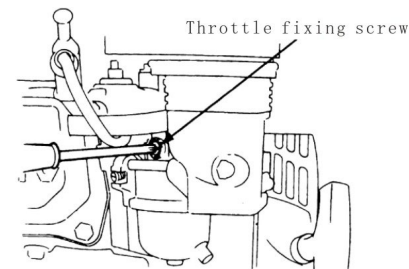

## **TRANSPORT, STORAGE AND REMOVAL FROM STORAGE**

### **Transport**

Transport with the fuel cock turned off. Transport or store the engine when it is cool so as to avoid getting burns or fire.

**CAUTION:**

**Do not incline the engine so as to avoid fuel's spill. Spilled fuel or fuel vapor may ignite to cause fire.**

### Storage

If the engine is not kept in use for a long time, be sure to store it properly. Make sure the storage area is dry and free of dust.

1. Replace engine oil.
2. Disconnect the spark plug. Fill about a spoon of fresh engine oil from the spark plug mount hole onto the cylinder. Crank the engine up to distribute engine oil evenly. Reinstall the spark plug.
3. Pull the starting rope slowly until feeling a slight anti-action, and then keep pulling it so as to align the arrow of the starting sleeve with the hole of the starter. At this time, both the inlet and outlet valves are closed so help prevent the engine inside from rusting.
4. Electric starter: disconnect the battery and store in dry and cool area. Charge one every month.
5. Cover the engine so keep dust away.

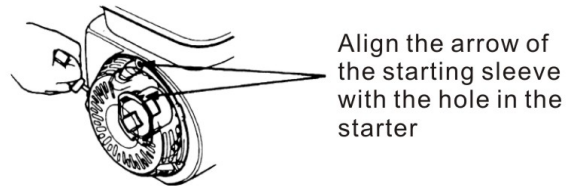
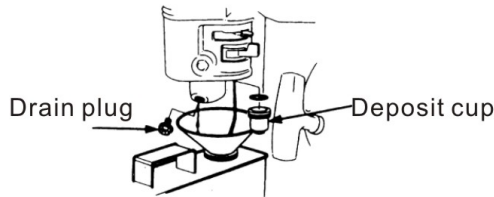

## Removal from storage

Before reusing, service the engine in accordance with the instruction of the table

STORAGE TIME	SERVICE ITEM
Within one month	Non
One ~ two months	Drain out original fuel of the fuel tank and refuel
Two month ~one year	Drain out original fuel of the fuel tank and refuel; Drain out fuel in the carburetor①; Empty the deposit cup②
Above one year	Drain out original fuel of the fuel tank and refuel; Empty the fuel cup in the carburetor①; Empty the deposit cup②

(1) Screw off the drain plug and drain out fuel in the carburetor.

(2) Turn off the engine switch first, disconnect the deposit cup and empty it.

Note: for the sake of environmental protection, we recommend to fill the discarded fuel into a closed container and bring to local recycling station. Never pour freely.

### **WARNING:**

**Fuel is extremely flammable and explosive under certain conditions. Keep cigarette, open flames and sparks away from operating site.**

## TROUBLESHOOTING

### I . START ENGINE DIFFICULTLY

#### 1. By using kick-starter

TROUBLE	CAUSE	REMEDY
1. Normal cylinder compression. 2. Normal spark plug spark. 3. Something wrong with the fuel system. 4. Fuel supply is not smooth or no fuel supply.	There is no enough fuel in fuel tank of fuel cock is closed.	Fill fuel, open fuel cock.
	Air vent in the fuel filler cap is clogged.	Dredge air vent.
	Fuel cock is clogged.	Clean first and then dredge.
	Improper or clogged main oil flow hole.	Readjust or clean, blow to get through.
	Needle valve is not closed properly or start hole is clogged.	Dismantle needle valve and repair, clean, blow to get through.
	Float is damaged or sticking.	Repair float.

<b>TROUBLE</b>	<b>CAUSE</b>	<b>REMEDY</b>
1. Normal cylinder compression. 2. Normal spark plug spark. 3. Something wrong with the fuel system. 4. Smooth fuel flow.	Fuel is too filthy or deteriorated.	Replace.
	There is water in fuel.	Replace.
	Too much fuel in engine.	Drain extra fuel, dry up spark plug electrodes.
	Wrong fuel brand.	Select proper fuel brand corresponding with the requirements.
1. Normal cylinder compression. 2. Normal spark supply. 3. Normal high – pressure coil spark. 4. Spark plug is in bad conditions.	Too much carbon deposit and dirt around electrodes.	Clear away.
	Electrodes are burn damaged seriously or insulators damaged.	Replace spark plug.
	Improper electrodes gap.	Adjust to proper value.

<b>TROUBLE</b>	<b>CAUSE</b>	<b>REMEDY</b>
1. Normal cylinder compression. 2. Normal fuel supply. 3. Normal high – pressure coil spark. 4. Normal spark plug.	High – pressure coil is damaged.	Replace
	Ignition coil is damaged.	Replace
	Magneto loses magnetism.	Replace
1. Poor cylinder compression. 2. Normal fuel supply system. 3. Normal ignition system.	Piston ring is worn to or even over its wear limit.	Replace
	Piston ring is broken.	Replace
	Piston ring is sticking.	Clear up carbon fouling.
	Spark plug is not installed tighten or without a gasket.	Tighten with a gasket in.
	Air leakage between cylinder block and cylinder head.	Check cylinder gasket, and the flatness of the surface by which cylinder block contacting with cylinder head, tighten cylinder head bolts in stipulated order to stipulated torque.

<b>TROUBLE</b>	<b>CAUSE</b>	<b>REMEDY</b>
Do.	Air leakage in valves.	Check valve. Clearance and tightness, repair if necessary.

**WARNING:**

- When testing the spark plug, never hold the high- voltage wire of the spark plug with wet hand.
- Make sure there is no spilled fuel outside the engine and that the spark plug isn't dipped with fuel.
- To prevent fire, keep sparks far away from the spark plug mount hole.

**1. By using starting motor**

<b>ITEM</b>	<b>CAUSE</b>	<b>REMEDY</b>
Check battery connection	Incorrect connection	Correct
Check battery	No charge or under charge, corrosion	Check the breaker, charge up the battery or replace it
Starting motor for functions normally	Be the same as kick-starter	Conduct it in the same way of kick-starter

Once you find any of above problems, contact the authorization entitle to the dealer of the privilege helps

for you.

## II. LOW GASOLING ENGINE POWER OUTPUT

TROUBLE	CAUSE		REMEDY
When turning throttle greater, speed increase responds slowly or speed is decreased even engine stops running.	Ignition system	Incorrect ignition time.	Readjust ignition advance angle
	Fuel supply system	Air in fuel line or fuel line clogged.	Exhaust air or dredge fuel line
		Main oil flow hole is not adjusted properly.	Readjust
		In carburetor, needle valve hole and main oil flow hole clogged.	Clean and blow to get through
		Fuel cock is clogged up.	Clean, replace damaged part
		Too much carbon deposit in combusting chamber.	Clear away

TROUBLE	CAUSE		REMEDY
do.	do.	Too much carbon fouling in muffler and exhaust pipe.	Clear away
		Air cleaner is clogged up.	Clean air cleaner filter element
		Intake pipe is leaking.	Repair or replace
	Poor compression	Piston or cylinder or piston ring is worn.	Replace the worn
		Air leakage from the surface by which cylinder block contacting with cylinder head.	Replace cylinder gasket
		Too big or too small valve clearance.	Readjust
		Valve tightness is poor.	Repair

### III. GASOLINE ENGINE CANNOT RUN SMOOTHLY

TROUBLE	CAUSE	REMEDY
Engine is pinking	Piston, cylinder or piston ring is worn excessively.	Replace the worn
	Piston pin and piston pin hole are worn excessively.	Replace piston or piston pin
	Tie rod small head is worn excessively.	Replace tie rod
	Roller bearing for crankshaft main shaft is worn.	Replace roller bearing
Abnormal combustion	Engine is too hot	Shoot trouble
	Too much carbon deposit in combustion chamber	Clear away
	Improper gasoline brand or low gasoline quality	Replace with qualified gasoline
Engine cannot start because of spark lacking	There is water in float chamber	Clean
	Improper spark plug electrodes clearance	Adjust

<b>TROUBLE</b>	<b>CAUSE</b>	<b>REMEDY</b>
do.	Incorrect ignition time	Readjust
	Something wrong with induced coil, and so on	Check and replace damaged parts

#### **IV. STOP SUDDENLY WHEN RUNNING**

<b>TROUBLE</b>	<b>CAUSE</b>		<b>REMEDY</b>
Stop suddenly when running.	Fuel supply system	Fuel is used up	Refill fuel
		Carburetor is clogged	Check fuel line and dredge
		Float is leaking	Repair
		Needle valve sticks	Dismantle float chamber and eliminate it
	Ignition system	Spark plug is struck through, or short-circuited by carbon deposit	Replace spark plug

TROUBLE	CAUSE		REMEDY
do.	do.	Side electrode of spark plug is dropped out	Replace spark plug
		High-pressure wire is dropped out	Weld on
		Ignition coil is struck through to be short-circuited	Replace ignition coil
		Parking wire is located on engine body	Find out meeting and insulate
	The other	Cylinder is pulled damage, valve is dropped out	Repair or replace damaged parts

## V. GASOLINE ENGINE IS EXCESSIVELY HOT

<b>TROUBLE</b>	<b>CAUSE</b>	<b>REMEDY</b>
Gasoline engine is excessively hot	Improper ignition time	Adjust ignition advance angle properly
	Insufficient fuel supply	Refill engine oil
	Exhaust pipe is blocked up	Dredge exhaust pipe
	Flow guard is leaking	Repair damaged part
	Dirt or something like this fill up among air cooling fins	Clear away dirt or something like this
	Cooling fan is loosen, losing function	Reinstall well
	Tie rod deformation makes piston and cylinder bushing side wear	Replace tie rod

TROUBLE	CAUSE	REMEDY
do.	Cylinder or piston or piston ring is worn, resulting in air flow between cylinder and crankcase	Replace the worn
	Improper adjustment of engine speed produces excessive rotational speed	Readjust engine speed to proper valve by speed regulator
	Crankshaft main bearing is burnt out	Replace main bearing

**NOTE:** the gasoline should run under cretin temperature. Generally, permitting temperature at the flow guard outlet is between 80- 110°C, while the temperature of the crankcase is about 60°C under the magneto. If temperatures surpass the limits, it is an indication that the gasoline engine is excessive hot.

## VI. THERE EXISTS ABNORMAL NOISE WHEN ENGINE RUNNING

TROUBLE	CAUSE	REMEDY
There is noise of beating	Piston, piston ring or cylinder is worn	Replace the worn
	Tie rod or piston pin and piston pin hole is worn	Replace the worn
	Crankshaft main bearing is worn	Replace
	Piston ring is broken	Replace
	Too much carbon deposit in combusting chamber	Clear away carbon deposit
	Too small electrode clearance of spark plug	Adjust electrode clearance properly
	Engine is flooded with fuel	Check relative parts such as carburetor
	Improper fuel brand	Replace fuel
	Engine is excessively hot	Find a cause and eliminate it

<b>TROUBLE</b>	<b>CAUSE</b>	<b>REMEDY</b>
The other	Improper valve clearance	Readjust valve clearance properly
	Fly wheel is not connected with crankshaft tightly	Connect tightly

## **SPECIFICATIONS**

### **MAIN SPECIFICATION**

<b>Model</b>	<b>192F-2T</b>
<b>Items</b>	
L × W × H (mm)	500 × 380 × 457
Dry weight (kg)	32
Engine type	4-stroke, OHV, single cylinder tilt 25 °C
Displacement (cm <sup>3</sup> )	459

<b>Model</b>	<b>192F-2T</b>
<b>Items</b>	
Bore × Stroke (mm)	92 × 69
Max. theory power 【kW (PS)/r/min】	12
Using power recommended 【kW (PS)/r/min】	11
Max. torque (N • m/r/min)	31 N.m/2900r
Fuel consume. (g/kWh)	395
Cooling system	Force air-cooled
Ignition system	TCI
Spark plug type	BPR6ES(NGK).NHSP LD F7TC
Lubrication mode	Splash
Output direction of power shaft	Counterclockwise

#### **DATE RELATING ADJUSTMENT**

<b>Item</b>	<b>Date</b>
<b>Spark plug clearance</b>	<b>0.7~0.8mm</b>
<b>Carburetor</b>	<b>1500±100rpm</b>
<b>Valve clearance (cold engine)</b>	<b>Intake: 0.15±0.02mm;</b>

## ELECTRIC DIAGRAM(for electric-start type)

B1	Black	Gr	Grey
Y	Yellow	R	Red
W	White	G	Green

Switch combination

	IG	E	ST	BAT
OFF	○—○			
ON				
START			○—○	

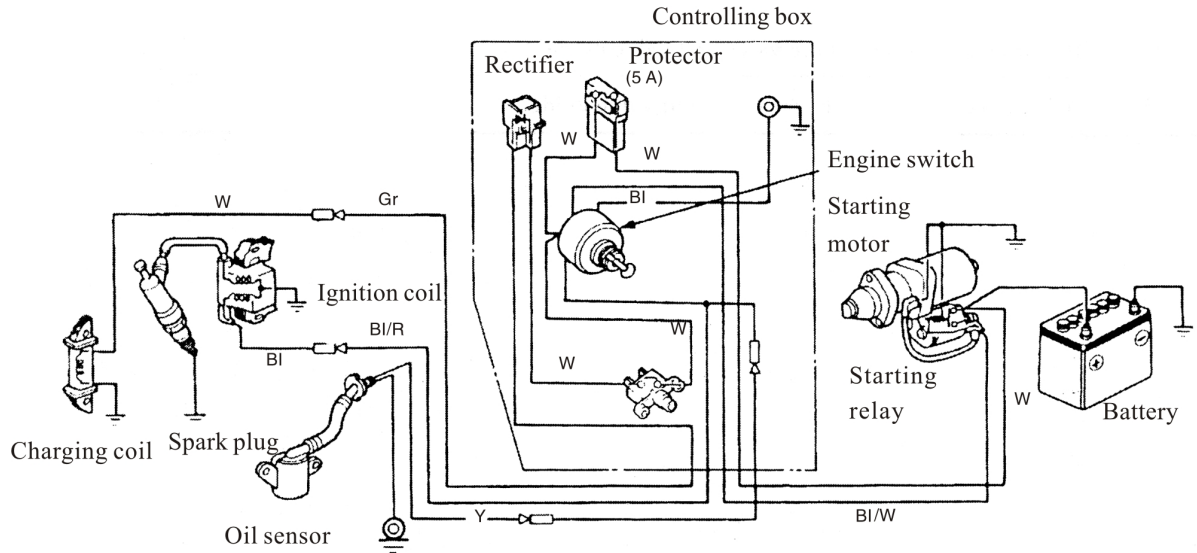

B1	Black
Y	Yellow
G	Green

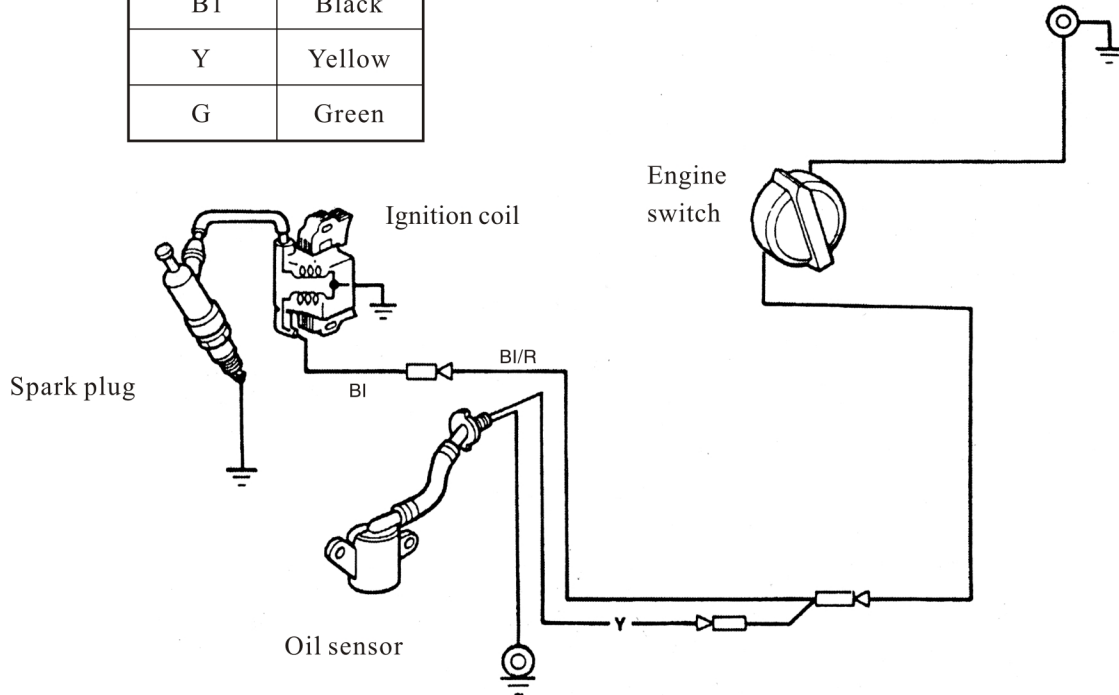

Note: The diagram for other types may be different with the exception of electric-start type.